

Optocoupler, Phototriac Output, High dV/dt, Low Input Current

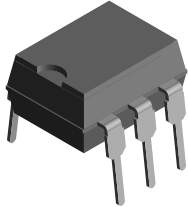

I179035

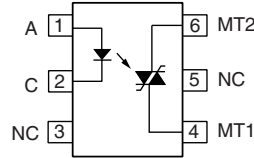

DESCRIPTION

The IL420/IL4208 consists of a GaAs IRLED optically coupled to a photosensitive non-zero crossing TRIAC network. The TRIAC consists of two inverse parallel connected monolithic SCRs. These three semiconductors are assembled in a six pin dual in-line package.

High input sensitivity is achieved by using an emitter follower phototransistor and a cascaded SCR predriver resulting in an LED trigger current of less than 2.0 mA (DC).

The IL420/IL4208 used two discrete SCRs resulting in a commutating dV/dt of greater than 10 kV/μs. The use of a proprietary dV/dt clam results in a static dV/dt of greater than 10 kV/μs. This clamp circuit has a MOSFET that is enhanced when high dV/dt spikes occur between MT1 and MT2 of the TRIAC. When conducting, the FET clamps the base of the phototransistors, disabling the first stage SCR predriver.

The 600/800 V blocking voltage permits control of offline voltages up to 240 VAC, with a safety factor of more than two, and is sufficient for as much as 380 VAC.

The IL420/IL4208 isolates low-voltage logic from 120, 240, and 380 VAC lines to control resistive, inductive, or capacitive loads including motors, solenoids, high current thyristors or TRIAC and relays.

FEATURES

- High input sensitivity $I_{FT} = 2.0$ mA
- 600/800 V blocking voltage
- 300 mA on-state current
- High static dV/dt 10 kV/μs
- Inverse parallel SCRs provide commutating dV/dt > 10 kV/μs
- Very low leakage < 10 μA
- Isolation test voltage 5300 V_{RMS}
- Small 6-pin DIP package
- Lead (Pb)-free component
- Component in accordance to RoHS 2002/95/EC and WEEE 2002/96/EC

**RoHS
COMPLIANT**

APPLICATIONS

- Solid state relays
- Industrial controls
- Office equipment
- Consumer appliances

AGENCY APPROVALS

- UL1577, file no. E52744 system code H or J, double protection
- CSA 93751
- FIMKO and BSI IEC 60950; IEC 60065 only for IL4208
- DIN EN 60747-5-2 (VDE 0884)/DIN EN 60747-5-5 pending available with option 1

ORDER INFORMATION

PART	REMARKS
IL420	600 V V _{DRM} , DIP-6
IL4208	800 V V _{DRM} , DIP-6
IL420-X006	600 V V _{DRM} , DIP-6 400 mil (option 6)
IL420-X007	600 V V _{DRM} , SMD-6 (option 7)
IL420-X009	600 V V _{DRM} , SMD-6 (option 9)
IL4208-X007	800 V V _{DRM} , SMD-6 (option 7)
IL4208-X009	800 V V _{DRM} , SMD-6 (option 9)

Note

For additional information on the available options refer to option information.



ABSOLUTE MAXIMUM RATINGS (1)					
PARAMETER	TEST CONDITION	PART	SYMBOL	VALUE	UNIT
INPUT					
Reverse voltage			V_R	6.0	V
Forward current			I_F	60	mA
Surge current			I_{FSM}	2.5	A
Power dissipation			P_{diss}	100	mW
Derate from 25 °C				1.33	mW/°C
OUTPUT					
Peak off-state voltage		IL420	V_{DRM}	600	V
		IL4208	V_{DRM}	800	V
RMS on-state current			I_{TM}	300	mA
Single cycle surge current			I_{TSM}	3.0	A
Power dissipation			P_{diss}	500	mW
Derate from 25 °C				6.6	mW/°C
COUPLER					
Isolation test voltage (2)	t = 1.0 s		V_{ISO}	5300	V_{RMS}
Pollution degree (DIN VDE 0109)				2	
Creepage distance				≥ 7.0	mm
Clearance distance				≥ 7.0	mm
Comparative tracking (3)				≥ 175	
Isolation resistance	$V_{IO} = 500\text{ V}, T_{amb} = 25\text{ °C}$		R_{IO}	≥ 10^{12}	Ω
	$V_{IO} = 500\text{ V}, T_{amb} = 100\text{ °C}$		R_{IO}	≥ 10^{11}	Ω
Storage temperature range			T_{stg}	- 55 to + 150	°C
Ambient temperature range			T_{amb}	- 55 to + 100	°C
Soldering temperature (4)	max. ≤ 10 s dip soldering ≥ 0.5 mm from case bottom		T_{sld}	260	°C

Notes

- (1) $T_{amb} = 25\text{ °C}$, unless otherwise specified.
Stresses in excess of the absolute maximum ratings can cause permanent damage to the device. Functional operation of the device is not implied at these or any other conditions in excess of those given in the operational sections of this document. Exposure to absolute maximum ratings for extended periods of the time can adversely affect reliability.
- (2) Between emitter and detector, climate per DIN 50014, part 2, Nov. 74.
- (3) Index per DIN IEC 60112/VDE 0303 part 1, group IIIa per DIN VDE 6110.
- (4) Refer to reflow profile for soldering conditions for surface mounted devices (SMD). Refer to wave profile for soldering conditions for through hole devices (DIP).



ELECTRICAL CHARACTERISTICS							
PARAMETER	TEST CONDITION	PART	SYMBOL	MIN.	TYP.	MAX.	UNIT
INPUT							
Forward voltage	$I_F = 10 \text{ mA}$		V_F		1.16	1.35	V
Reverse current	$V_R = 6.0 \text{ V}$		I_R		0.1	10	μA
Input capacitance	$V_F = 0 \text{ V}, f = 1.0 \text{ MHz}$		C_{IN}		40		pF
Thermal resistance, junction to ambient			R_{thja}		750		$^{\circ}\text{C/W}$
OUTPUT							
Off-state voltage	$I_{D(RMS)} = 70 \mu\text{A}$	IL420	$V_{D(RMS)}$	424	460		V
		IL4208	$V_{D(RMS)}$	565			V
Repetitive peak off-state voltage	$I_{DRM} = 100 \mu\text{A}$	IL420	V_{DRM}	600			V
		IL4208	V_{DRM}	800			V
Off-state current	$V_D = V_{DRM}, T_{amb} = 100 \text{ }^{\circ}\text{C}$		I_{BD}		10	100	μA
On-state voltage	$I_T = 300 \text{ mA}$		V_{TM}		1.7	3.0	V
On-current	$PF = 1.0, V_{T(RMS)} = 1.7 \text{ V}$		I_{TM}			300	mA
Surge (non-repetitive), on-state current	$f = 50 \text{ Hz}$		I_{TSM}			3.0	A
Holding current			I_H		65	500	μA
Latching current	$V_T = 2.2 \text{ V}$		I_L		5.0		mA
LED trigger current	$V_{AK} = 5.0 \text{ V}$		I_{FT}		1.0	2.0	
Trigger current temperature gradient			$\Delta I_{FT}/\Delta T_j$		7.0	14	$\mu\text{A}/^{\circ}\text{C}$
Critical rate of rise off-state voltage	$V_D = 0.67 V_{DRM}, T_j = 25 \text{ }^{\circ}\text{C}$		dV/dt_{cr}	10000			V/ μs
	$V_D = 0.67 V_{DRM}, T_j = 80 \text{ }^{\circ}\text{C}$		dV/dt_{cr}	5000			V/ μs
Critical rate of rise of voltage at current commutation	$V_D = 0.67 V_{DRM}, dl/dt_{crq} \leq 15 \text{ A/ms}, T_j = 25 \text{ }^{\circ}\text{C}$		dV/dt_{crq}	10000			V/ μs
	$V_D = 0.67 V_{DRM}, dl/dt_{crq} \leq 15 \text{ A/ms}, T_j = 80 \text{ }^{\circ}\text{C}$		dV/dt_{crq}	5000			V/ μs
Critical rate of rise of on-state			dl/dt_{cr}	8.0			A/ μs
Thermal resistance, junction to ambient			R_{thja}		150		$^{\circ}\text{C/W}$
COUPLER							
Critical rate of rise of coupled input/output voltage	$I_T = 0 \text{ A}, V_{RM} = V_{DM} = V_{D(RMS)}$		dV/dt		5000		V/ μs
Capacitance (input to output)	$f = 1.0 \text{ MHz}, V_{IO} = 0 \text{ V}$		C_{IO}		0.8		pF
Isolation resistance	$V_{IO} = 500 \text{ V}, T_{amb} = 25 \text{ }^{\circ}\text{C}$		R_{IO}	$\geq 10^{12}$			Ω
	$V_{IO} = 500 \text{ V}, T_{amb} = 100 \text{ }^{\circ}\text{C}$		R_{IO}	$\geq 10^{11}$			Ω

Note

$T_{amb} = 25 \text{ }^{\circ}\text{C}$, unless otherwise specified.

Minimum and maximum values are testing requirements. Typical values are characteristics of the device and are the result of engineering evaluation. Typical values are for information only and are not part of the testing requirements.

SWITCHING CHARACTERISTICS						
PARAMETER	TEST CONDITION	SYMBOL	MIN.	TYP.	MAX.	UNIT
Turn-on time	$V_{RM} = V_{DM} = V_{D(RMS)}$	t_{on}		35		μs
	$PF = 1.0, I_T = 300 \text{ mA}$	t_{off}		50		μs

SAFETY AND INSULATION RATINGS						
PARAMETER	TEST CONDITION	SYMBOL	MIN.	TYP.	MAX.	UNIT
Climatic classification (according to IEC 68 part 1)				55/100/21		
Comparative tracking index		CTI	175		399	
V_{IOTM}			8000			V
V_{IORM}			630			V
P_{SO}					500	mW
I_{SI}					250	mA
T_{SI}					175	°C
Creepage distance	standard DIP-8		7			mm
Clearance distance	standard DIP-8		7			mm
Creepage distance	400 mil DIP-8		8			mm
Clearance distance	400 mil DIP-8		8			mm
Insulation thickness	for IL4208 only		0.4			mm

Note

As per IEC 60747-5-2, § 7.4.3.8.1, this optocoupler is suitable for "safe electrical insulation" only within the safety ratings. Compliance with the safety ratings shall be ensured by means of protective circuits.

TYPICAL CHARACTERISTICS

$T_{amb} = 25\text{ °C}$, unless otherwise specified

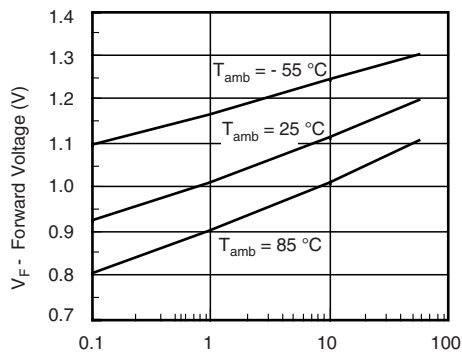

Fig. 1 - Forward Voltage vs. Forward Current

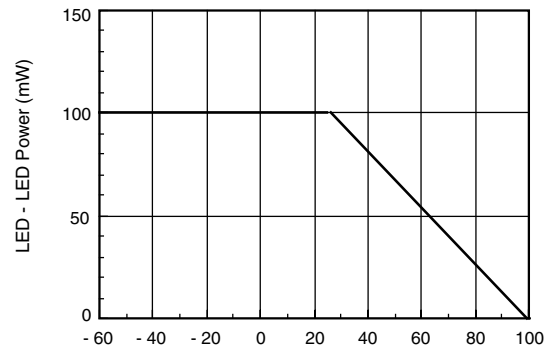

Fig. 3 - Maximum LED Power Dissipation

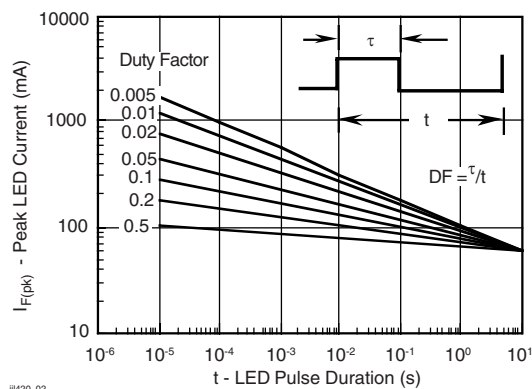

Fig. 2 - Peak LED Current vs. Duty Factor, τ

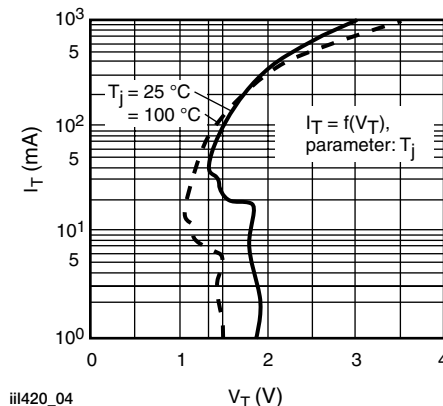

Fig. 4 - Typical Output Characteristics

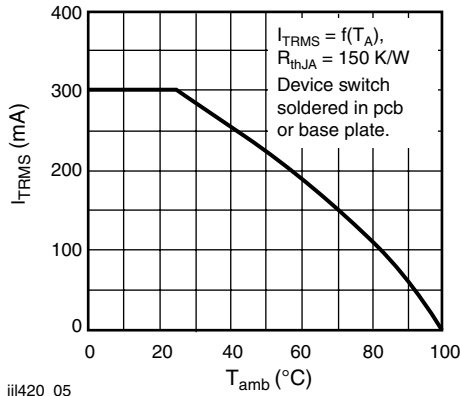

Fig. 5 - Current Reduction

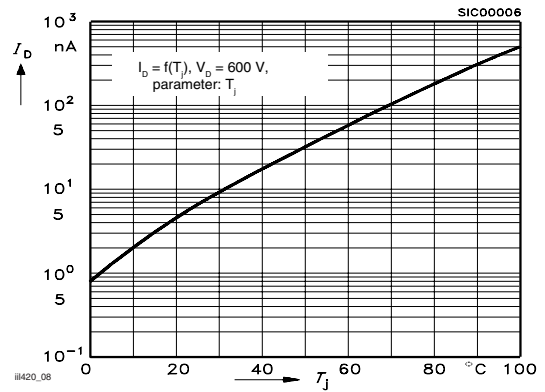

Fig. 8 - Typical Off-State Current

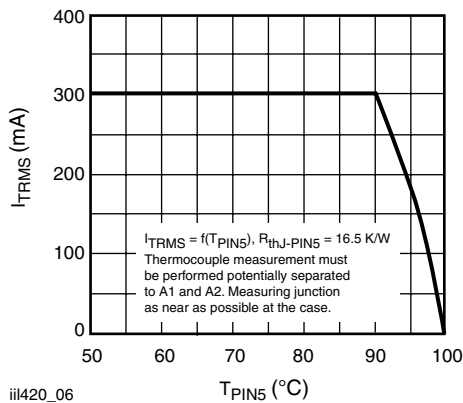

Fig. 6 - Current Reduction

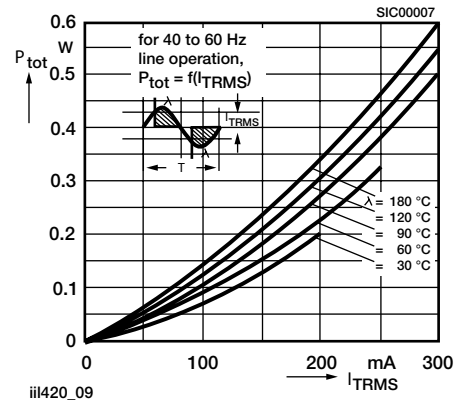

Fig. 9 - Power Dissipation

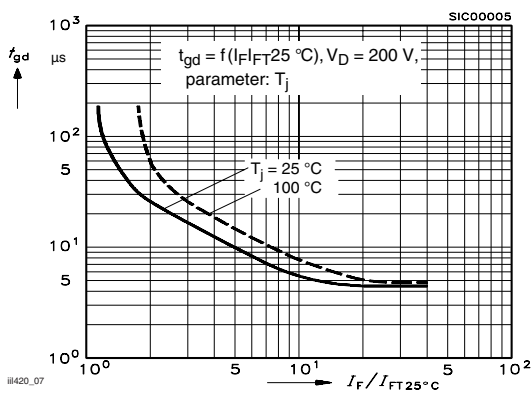

Fig. 7 - Typical Trigger Delay Time

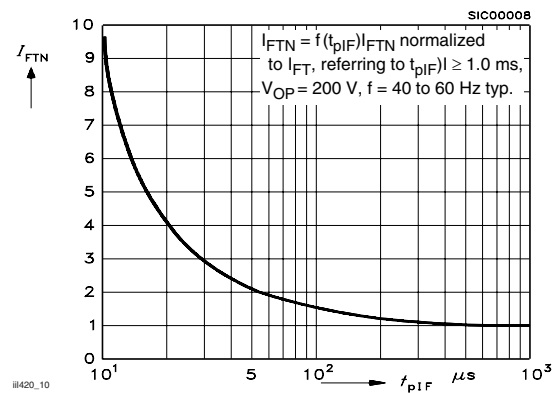

Fig. 10 - Pulse Trigger Current

IL420/IL4208

Vishay Semiconductors

Optocoupler, Phototriac Output,
High dV/dt, Low Input Current



PACKAGE DIMENSIONS in inches (millimeters)

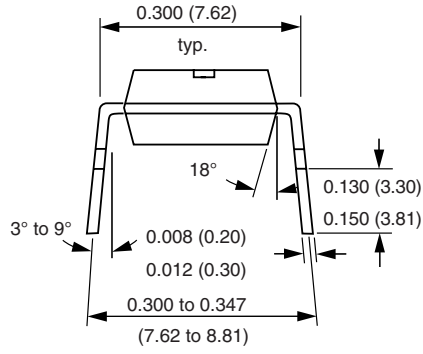
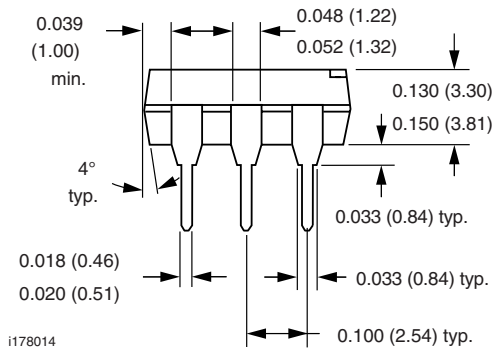
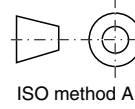
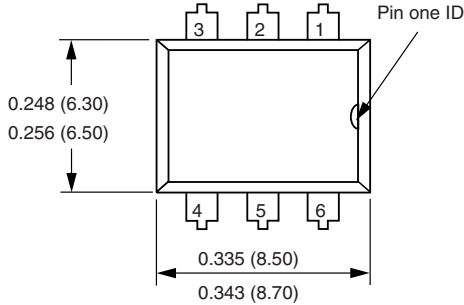

Option 6

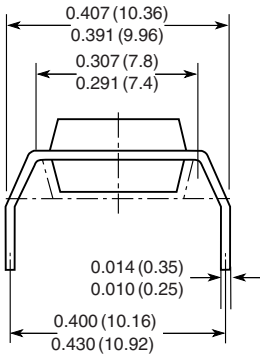

Option 7

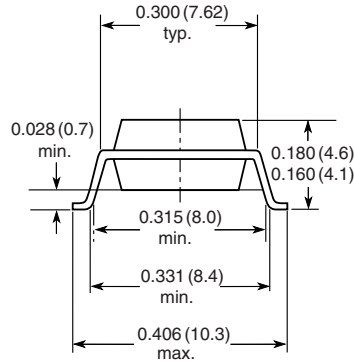

Option 9

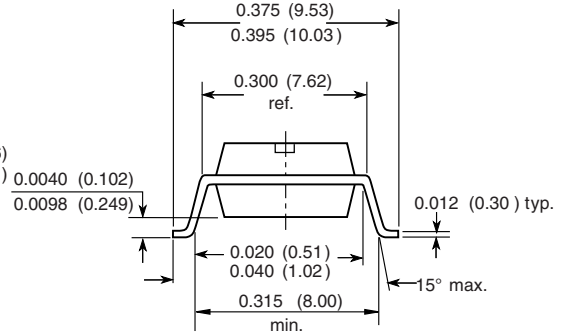

18450

**OZONE DEPLETING SUBSTANCES POLICY STATEMENT**

It is the policy of Vishay Semiconductor GmbH to

1. Meet all present and future national and international statutory requirements.
2. Regularly and continuously improve the performance of our products, processes, distribution and operating systems with respect to their impact on the health and safety of our employees and the public, as well as their impact on the environment.

It is particular concern to control or eliminate releases of those substances into the atmosphere which are known as ozone depleting substances (ODSs).

The Montreal Protocol (1987) and its London Amendments (1990) intend to severely restrict the use of ODSs and forbid their use within the next ten years. Various national and international initiatives are pressing for an earlier ban on these substances.

Vishay Semiconductor GmbH has been able to use its policy of continuous improvements to eliminate the use of ODSs listed in the following documents.

1. Annex A, B and list of transitional substances of the Montreal Protocol and the London Amendments respectively.
2. Class I and II ozone depleting substances in the Clean Air Act Amendments of 1990 by the Environmental Protection Agency (EPA) in the USA.
3. Council Decision 88/540/EEC and 91/690/EEC Annex A, B and C (transitional substances) respectively.

Vishay Semiconductor GmbH can certify that our semiconductors are not manufactured with ozone depleting substances and do not contain such substances.

We reserve the right to make changes to improve technical design
and may do so without further notice.

Parameters can vary in different applications. All operating parameters must be validated for each customer application by the customer. Should the buyer use Vishay Semiconductors products for any unintended or unauthorized application, the buyer shall indemnify Vishay Semiconductors against all claims, costs, damages, and expenses, arising out of, directly or indirectly, any claim of personal damage, injury or death associated with such unintended or unauthorized use.

Vishay Semiconductor GmbH, P.O.B. 3535, D-74025 Heilbronn, Germany



Disclaimer

All product specifications and data are subject to change without notice.

Vishay Intertechnology, Inc., its affiliates, agents, and employees, and all persons acting on its or their behalf (collectively, "Vishay"), disclaim any and all liability for any errors, inaccuracies or incompleteness contained herein or in any other disclosure relating to any product.

Vishay disclaims any and all liability arising out of the use or application of any product described herein or of any information provided herein to the maximum extent permitted by law. The product specifications do not expand or otherwise modify Vishay's terms and conditions of purchase, including but not limited to the warranty expressed therein, which apply to these products.

No license, express or implied, by estoppel or otherwise, to any intellectual property rights is granted by this document or by any conduct of Vishay.

The products shown herein are not designed for use in medical, life-saving, or life-sustaining applications unless otherwise expressly indicated. Customers using or selling Vishay products not expressly indicated for use in such applications do so entirely at their own risk and agree to fully indemnify Vishay for any damages arising or resulting from such use or sale. Please contact authorized Vishay personnel to obtain written terms and conditions regarding products designed for such applications.

Product names and markings noted herein may be trademarks of their respective owners.